

Y

Y7P/Y10P Manual 1.2 en

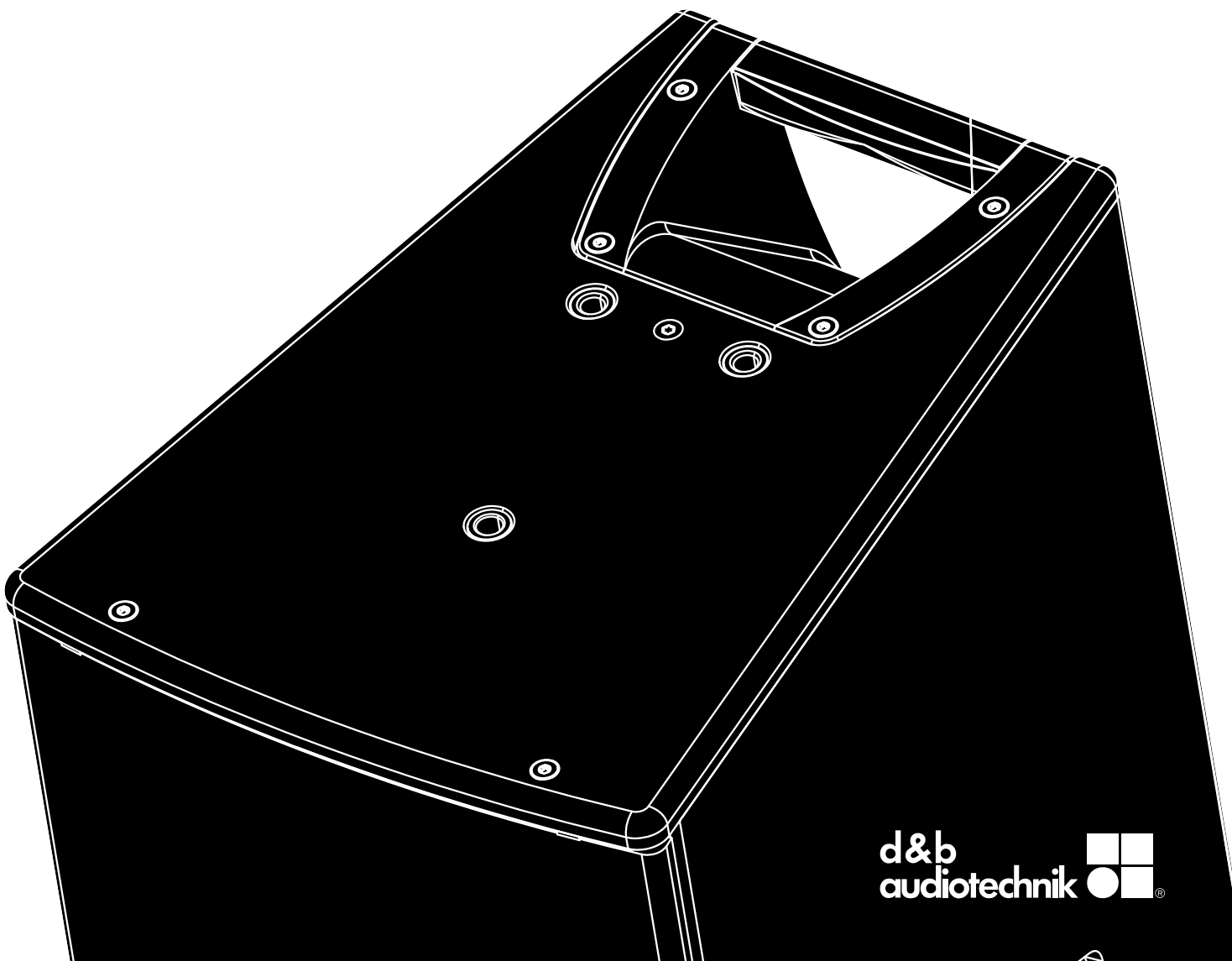

General information

Y7P/Y10P Manual

Version: 1.2 en, 10/2016, D2710.EN .01

Copyright © 2016 by d&b audiotechnik GmbH; all rights reserved.

Keep this document with the product or in a safe place so that it is available for future reference.

We recommend you to regularly check the d&b website for the latest version of this document.

When reselling this product, hand over this document to the new owner.

If you supply d&b products, please draw the attention of your customers to this document. Enclose the relevant documents with the systems. If you require additional documents for this purpose, you can order them from d&b.

d&b audiotechnik GmbH
Eugen-Adolf-Strasse 134, D-71522 Backnang, Germany
T +49-7191-9669-0, F +49-7191-95 00 00

1	Safety precautions	4
1.1	Information regarding the use of loudspeakers.....	4
2	Y7P/Y10P loudspeaker	5
2.1	Product description.....	5
2.2	Connections.....	6
2.3	Operation.....	6
2.3.1	Controller settings.....	6
2.4	Dispersion characteristics.....	8
2.5	Technical specifications.....	10
3	Manufacturer's declarations	12
3.1	EU conformity of loudspeakers (CE symbol).....	12
3.1.1	WEEE Declaration (Disposal).....	12

1.1 Information regarding the use of loudspeakers

Potential risk of personal injury

Never stand in the immediate vicinity of loudspeakers driven at a high level. Professional loudspeaker systems are capable of causing a sound pressure level detrimental to human health. Seemingly non-critical sound levels (from approx. 95 dB SPL) can cause hearing damage if people are exposed to it over a long period.

In order to prevent accidents when deploying loudspeakers on the ground or when flown, please take note of the following:

- When setting up the loudspeakers or loudspeaker stands, make sure they are standing on a firm surface. If you place several systems on top of one another, use straps to secure them against movement.
- Only use accessories which have been tested and approved by d&b for assembly and mobile deployment. Pay attention to the correct application and maximum load capacity of the accessories as detailed in our specific "Mounting instructions" or in our "Flying system and Rigging manuals".
- Ensure that all additional hardware, fixings and fasteners used for installation or mobile deployment are of an appropriate size and load safety factor. Pay attention to the manufacturers' instructions and to the relevant safety guidelines.
- Regularly check the loudspeaker housings and accessories for visible signs of wear and tear, and replace them when necessary.
- Regularly check all load bearing bolts in the mounting devices.

Potential risk of material damage

Loudspeakers produce a static magnetic field even if they are not connected or are not in use. Therefore make sure when erecting and transporting loudspeakers that they are nowhere near equipment and objects which may be impaired or damaged by an external magnetic field. Generally speaking, a distance of 0.5 m (1.5 ft) from magnetic data carriers (floppy disks, audio and video tapes, bank cards, etc.) is sufficient; a distance of more than 1 m (3 ft) may be necessary with computer and video monitors.

2 Y7P/Y10P loudspeaker

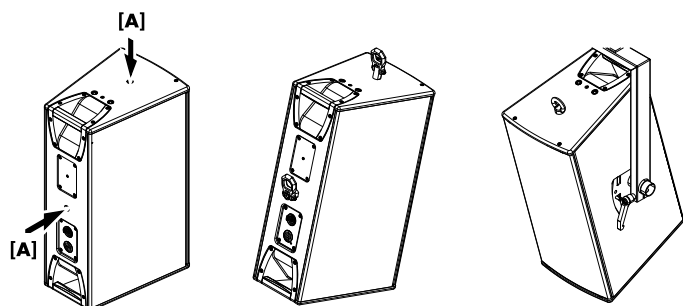
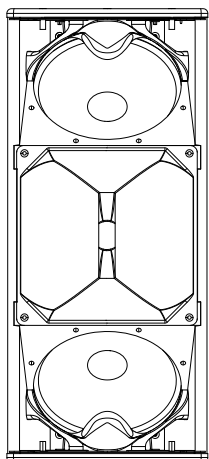

Additional combined sockets

2.1 Product description

Y7P/Y10P are passive 2-way loudspeakers housing two 8" LF drivers and a 1.4" HF compression driver with a rotatable CD horn producing a nominal dispersion (h x v) of 75° x 40° or 110° x 40°, respectively. The frequency response extends from 59 Hz to above 18 kHz.

The two 8" neodymium LF drivers are positioned in a dipolar arrangement providing exceptional vertical dispersion control even at lower frequencies.

Specially designed ports with optimized flow characteristics provide a considerably improved, efficient low frequency reproduction.

The cabinets are constructed from marine plywood and have an impact and weather protected PCP (Polyurea Cabinet Protection) finish. The top and bottom panels incorporate a handle each. The front of the loudspeaker cabinet is protected by a rigid metal grill backed by an acoustically transparent foam.

The cabinets accommodate fittings for three types of rigging devices:

- A quick lock adapter plate on one side of the cabinet that accepts the Z5397 YP Swivel bracket.
- Two M10 threaded inserts on the top and bottom panels each to accept the Z5399 YP Mounting bracket.
- Two additional combined sockets [A], one in the top panel and one at the center rear of the cabinet that accept either:
 - the Q9032 Safety eye bolt M10 to apply a secondary safety device.
 - the Z5049 Flying pin 8 mm to support single cabinets or to secure the aiming of an array.

Intended use of the Z5049 Flying pin

! WARNING!
Potential risk of personal injury and/or damage to material!

The Z5049 Flying pin 8 mm is designed and intended for static loads only. Therefore please observe the following:

- The Flying pin must not be used to attach a secondary safety device.
- Ensure the Flying pin is securely locked before lifting any load.

Proceed as follows:

1. Press the button to release the locking mechanism ([r] →).
2. Fully insert the Flying pin into the respective socket.
3. Release the button to lock the pin ([l] ←).
4. Recheck the Flying pin is securely locked by briefly pulling the Flying pin towards you.

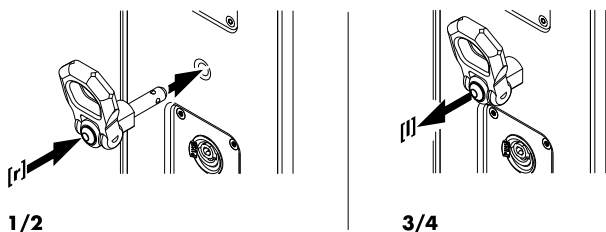

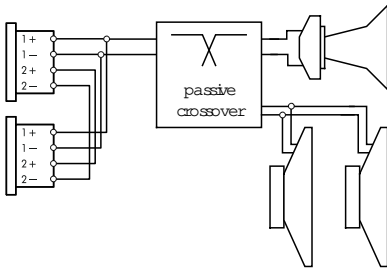

Connector wiring

2.2 2.2 Connections

The cabinets are fitted with a pair of NLT4 F/M connectors. All four pins of both connectors are wired in parallel. The cabinets use the pin assignments 1+/1-. Pins 2+/2- are designated to active subwoofers. Using the male connector as the input, the female connector allows for direct connection to a second cabinet.

The cabinets can be supplied with NL4 M or EP5 connectors as an option.

Pin equivalents of the connector options are listed in the table below.

NLT4 F/M NL4 M	1+	1-	2+	2-	n.a.
EP5	1	2	3	4	5

d&b LoadMatch

Starting with the D80 amplifier platform, the LoadMatch function enables the amplifier to electrically compensate for the properties of the loudspeaker cable used without the need for an additional sense wire. For applicable loudspeakers, LoadMatch is therefore independent of the connector type used.

2.3 Operation

NOTICE!

Only operate d&b loudspeakers with a correctly configured d&b amplifier, otherwise there is a risk of damaging the loudspeaker components.

Applicable d&b amplifiers:

D80/D20/D12/D6/10D/30D.

Application	Setup	Cabinets per channel
Y7P	Y7P	2
Y10P	Y10P	2

For applicable amplifiers, the controller setups are available in Dual Channel and Mix TOP/SUB mode.

2.3.1 Controller settings

For acoustic adjustment the functions CUT, HFA and CPL can be selected.

CUT mode

Set to CUT, the low frequency level is reduced. The cabinets are now configured for use with actively driven d&b subwoofers.

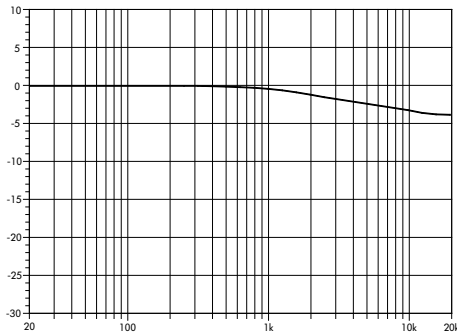

Frequency response correction in HFA mode

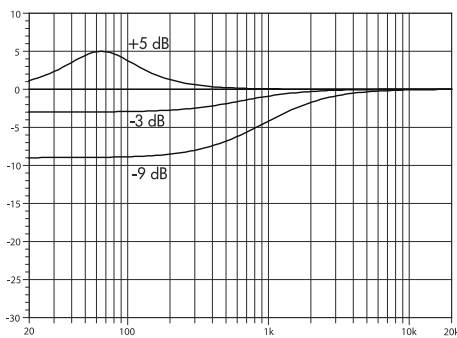

Frequency response correction of the CPL function

HFA mode

In HFA mode (High Frequency Attenuation), the HF response of the system is rolled off. HFA provides a natural, balanced frequency response when a cabinet is placed close to listeners in near field or delay use.

High Frequency Attenuation begins gradually at 1 kHz, dropping by approximately 3 dB at 10 kHz. This roll off mimics the decline in frequency response experienced when listening to a system from a distance in a typically reverberant room or auditorium.

CPL function

The CPL (Coupling) function compensates for coupling effects between the cabinet and close boundary surfaces. CPL begins gradually around 1 kHz, with the maximum attenuation below 400 Hz. To achieve a balanced frequency response, the CPL function can be set to dB attenuation values between 0 and -9.

Positive CPL values create an adjustable low frequency boost (0 to +5 dB) at around 65 Hz and can be set when the system is used in full range mode without subwoofers.

2.4 Dispersion characteristics

The following graphs show dispersion angle over frequency of a single cabinet plotted using lines of equal sound pressure (isobars) at -6 dB and -12 dB.

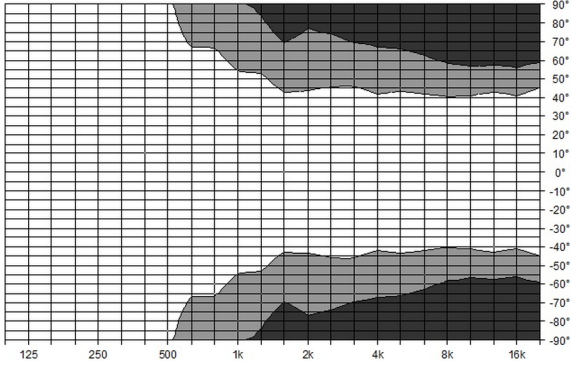

Isobar diagram horizontal



Y7P

vertical setup

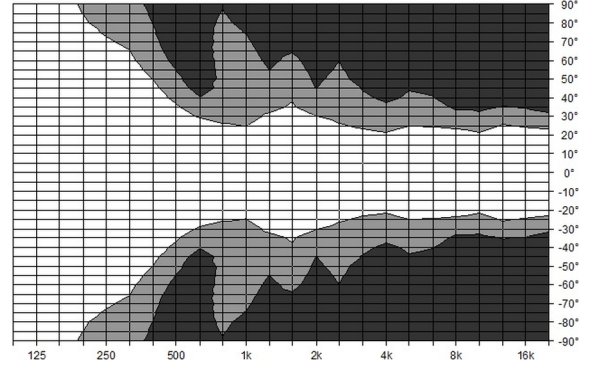

Isobar diagram vertical

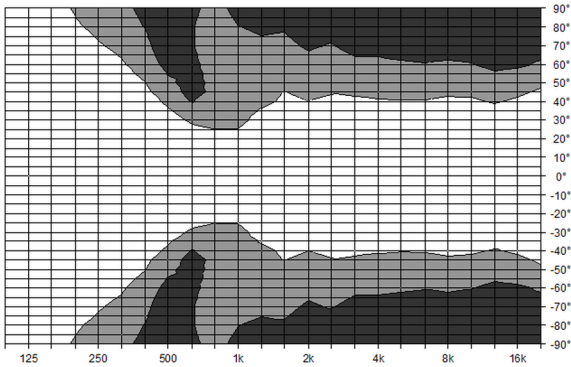

Isobar diagram horizontal

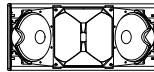

Y7P

horizontal setup,
horn rotated

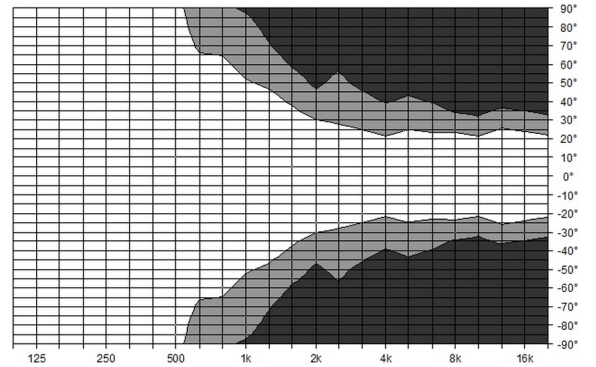

Isobar diagram vertical

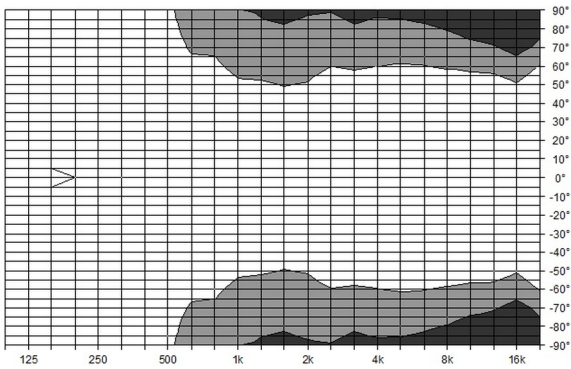

Isobar diagram horizontal



Y10P

vertical setup

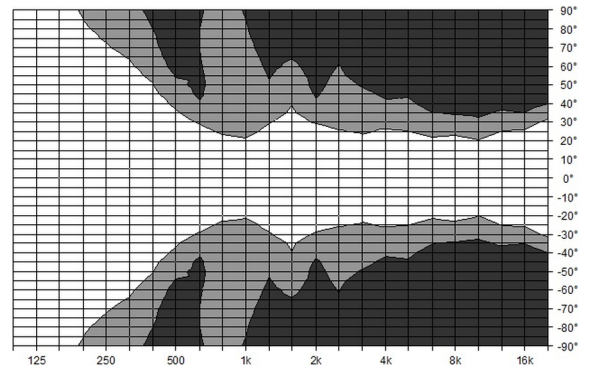

Isobar diagram vertical

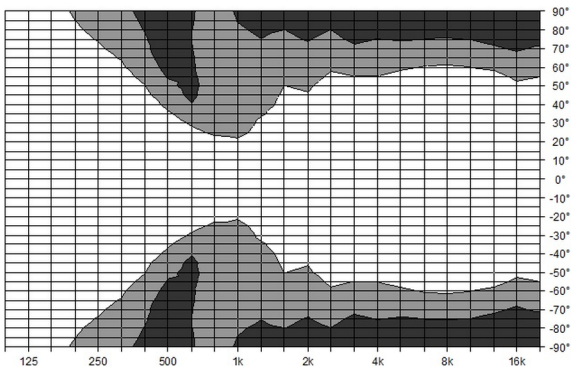

Isobar diagram horizontal

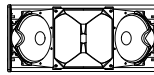

Y10P

horizontal setup,
horn rotated

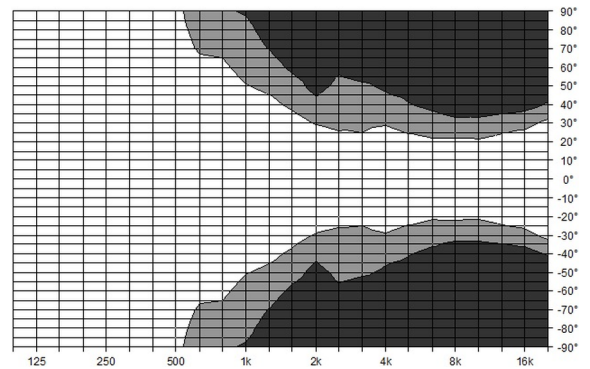

Isobar diagram vertical

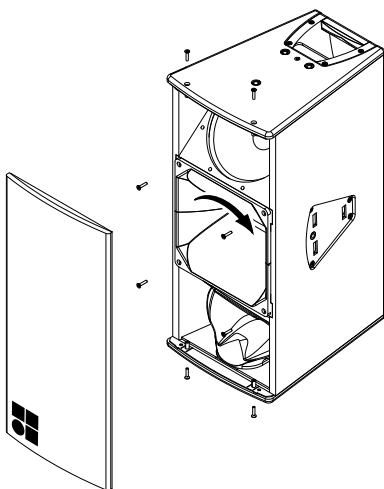
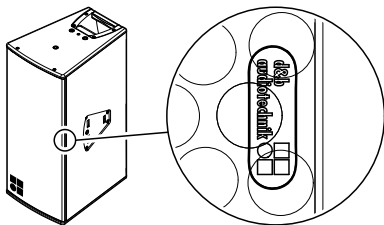

Altering the HF dispersion

Altering the HF horn dispersion

By factory default, the HF horn is fitted to the cabinet providing the nominal horizontal dispersion when the cabinet is used in upright position. This is indicated by a white label on the horn flange. The label is visible through the front grill on each side of the cabinet as shown in the graphic opposite.

The HF horn can be rotated through 90°.

Tools required: Torx wrench (#TX20).

1. Undo the torx screws on the top and bottom panels of the cabinet and remove the front grill.
2. Undo the screws holding the horn flange and rotate the horn.
3. Refit the horn as follows:
 - Make sure the gasket of the horn is in place.
 - Refit the horn.
 - Insert all screws and carefully tighten them clockwise until they fit precisely into the countersunk holes.
4. Refit the front grill.

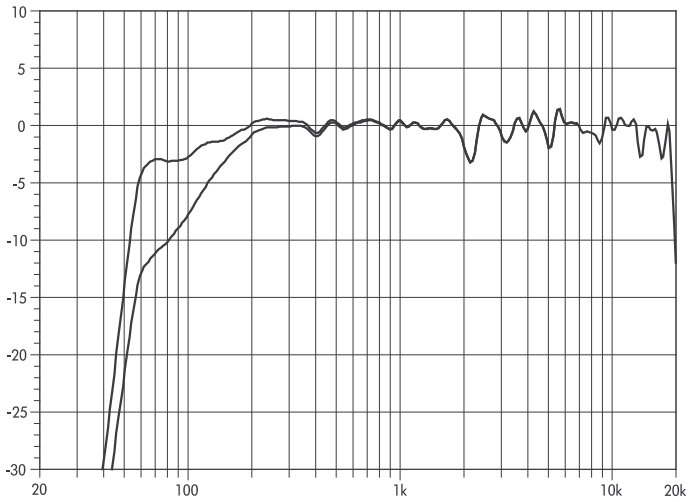

Y7P frequency response, standard and CUT modes

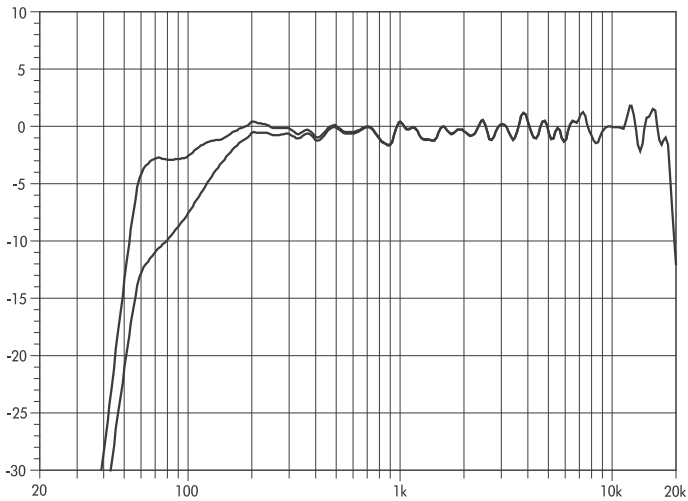

Y10P frequency response, standard and CUT modes

2.5 Technical specifications

Y7P/Y10P system data

Frequency response (-5 dB standard)	59 Hz - 18 kHz
Frequency response (-5 dB CUT mode)	118 Hz - 18 kHz
Max. sound pressure (1 m, free field)	
Y7P with D6/10D	132 dB
Y7P with D12/D20/30D	135 dB
Y7P with D80	137 dB
Y10P with D6/10D	131 dB
Y10P with D12/D20/30D	134 dB
Y10P with D80	136 dB
..... (SPLmax peak, pink noise test signal with crest factor of 4)	

Y7P/Y10P loudspeaker

Nominal impedance	8 ohms
Power handling capacity (RMS/peak 10 ms)	400/1600 W
Nominal dispersion angle (horizontal) Y7P	75°
Nominal dispersion angle (horizontal) Y10P	110°
Nominal dispersion angle (vertical)	40°
Components	2 x 8" driver with neodymium magnet
.....	1.4 " exit compression driver
.....	Passive crossover network
Connections	2 x NLT4 F/M
.....	optional 2 x NL4 M or EP5
Pin assignment	NLT4 F/M and NL4 M: 1+/1-
.....	EP5: 1: + / 2: -
Weight	18 kg (40 lb)

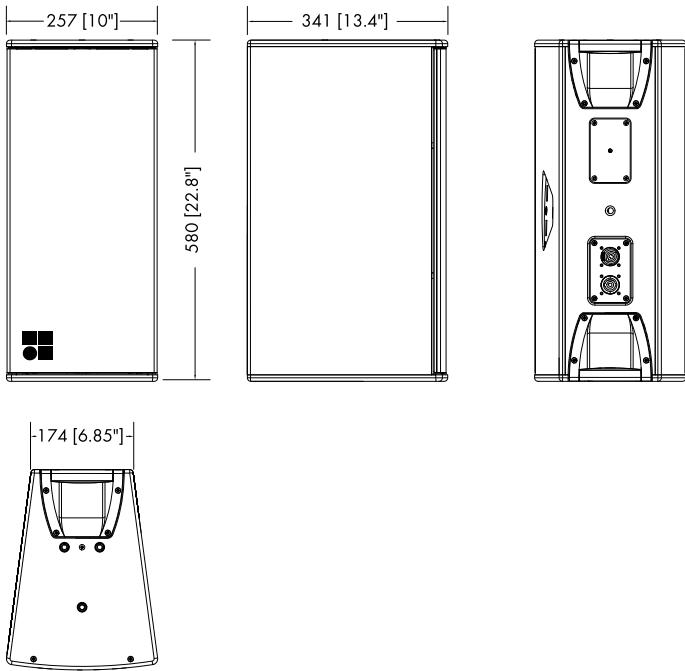

Y7P/Y10P cabinet dimensions in mm [inch]



3.1 EU conformity of loudspeakers (CE symbol)

This declaration applies to:

d&b Y7P loudspeaker, Z0702

d&b Y10P loudspeaker, Z0703

manufactured by d&b audiotechnik GmbH.

All production versions of these types are included, provided they correspond to the original technical version and have not been subject to any later design or electromechanical modifications.

We herewith declare that said products are in conformity with the provisions of the respective EC directives including all applicable amendments.

A detailed declaration is available on request and can be ordered from d&b or downloaded from the d&b website at www.dbaudio.com.

3.1.1 WEEE Declaration (Disposal)

Electrical and electronic equipment must be disposed of separately from normal waste at the end of its operational lifetime.

Please dispose of this product according to the respective national regulations or contractual agreements. If there are any further questions concerning the disposal of this product, please contact d&b audiotechnik.



